

# FF918CS-T Dual Beam Boat Fish Finder Manual Guide

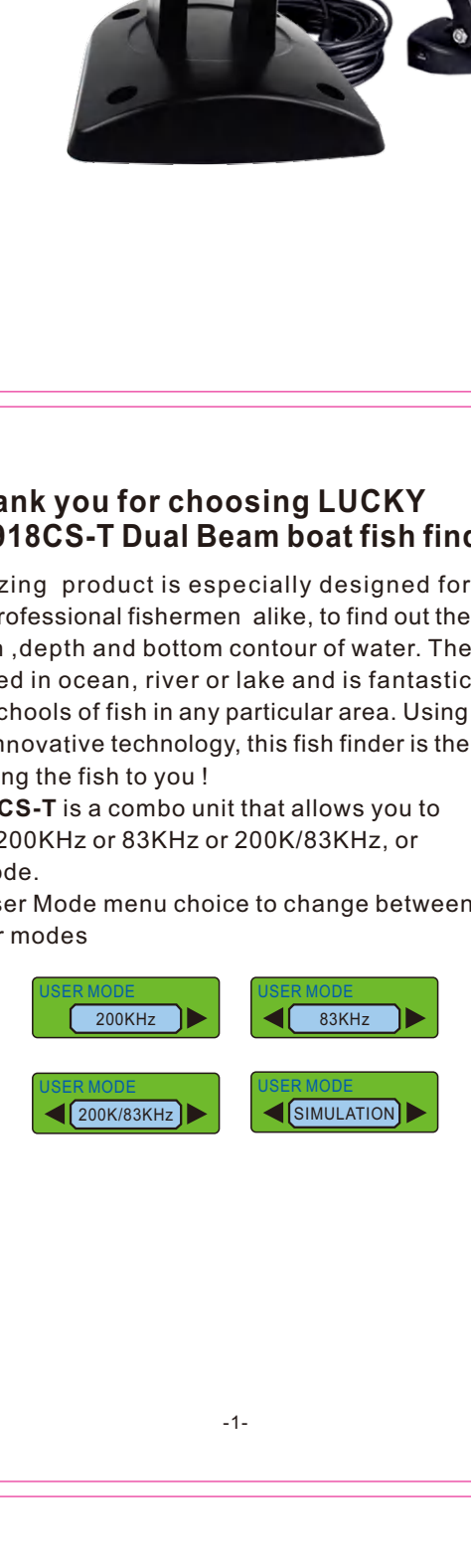

## 1. Thank you for choosing LUCKY FF918CS-T Dual Beam boat fish finder.

This amazing product is especially designed for amateur and professional fishermen alike, to find out the location of fish ,depth and bottom contour of water. The unit can be used in ocean, river or lake and is fantastic for detecting schools of fish in any particular area. Using amazing and innovative technology, this fish finder is the ideal tool to bring the fish to you!

The FF918CS-T is a combo unit that allows you to choose either 200KHz or 83KHz or 200K/83KHz, or Simulation mode.

Use the User Mode menu choice to change between these four user modes

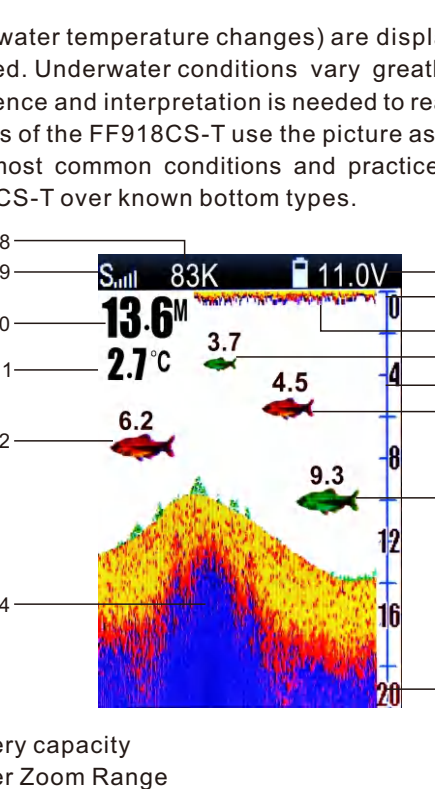

-1-

## 2. How FF918CS-T works

The FF918CS-T is the easiest to use fish finder ever. For most anglers,all you'll ever need to do is power on and fish! The FF918CS-T automatically determines depth and makes adjustments to keep the bottom and fish visible on the display.

The FF918CS-T uses sonar technology to send sound waves from the transducer into the water. The returned "echoes" are plotted on the display, creating a very accurate picture of the underwater world, including distance to underwater objects such as the bottom, fish and structure. The FF918CS-T uses a 200/83KHz Dual Beam sonar system.

When use 83KHz mode , the FF918CS-T can indicate fish found in the wide (60°) beam when the fish icon mode is turned on. When you use 200KHz mode, the FF918CS-T can indicate fish found in the wide (20°) beam when the fish icon mode is turned on. When you use 200/83KHz mode, the FF918CS-T can be optimized to show the greatest bottom definition using a narrow(20°) beam yet can still indicate fish found in the wide(60°) beam area when the fish icon mode is turned on. Dual Beam is ideal for a wide range of conditions from shallow to very deep water in both fresh and salt water. Boat speed, wave action, bottom hardness, water conditions and transducer installation can all affect depth capability.

-2-



## 3. Display View

The FF918CS-T displays underwater information in an easy-to-understand format. The top of the display corresponds to the water surface at the transducer, and the bottom of the display corresponds to the Depth Range automatically selected for the current water depth. The Bottom Contour varies as the depth under the boat changes. Digital readouts provide precise information for depth, fish and water temperature.

As the boat moves, terrain and bottom composition variations are displayed. Fish, baitfish and thermoclines (underwater temperature changes) are displayed when detected. Underwater conditions vary greatly, so some experience and interpretation is needed to realize all the benefits of the FF918CS-T use the picture as a guide to the most common conditions and practice using the FF918CS-T over known bottom types.

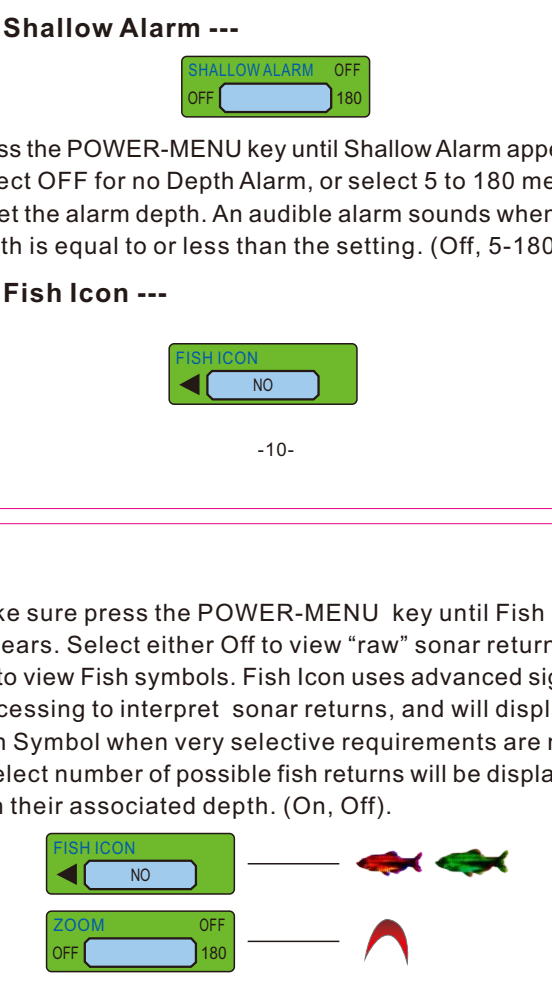

- 1-Battery capacity
- 2-Upper Zoom Range
- 3-Water Surface Line
- 4-Small Fish Icon
- 5-Depth ruler
- 6-Medium Fish Icon
- 7-Lower Zoom Range

-4-

- 8-User mode
- 9-Sensitivity
- 10-Water Depth
- 11-Water Temperature
- 12-Large Fish Icon(200KHz Narrow Beam Fish Icon)
- 13-83KHz Wide Beam Fish Icon
- 14-Bottom Contour

## 5.Powering ON and OFF

Press last 3seconds and release the POWER-MENU key to power the FF918CS-T on. Press and hold the POWER-MENU key until the unit shuts down to power off.

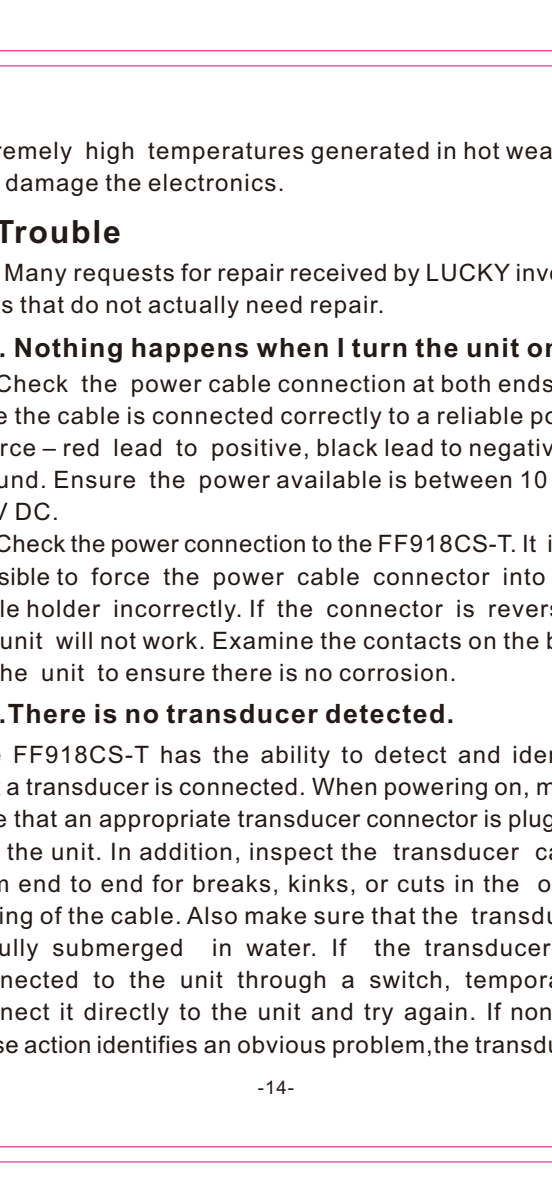

- 1-Up arrow key
- 2-Mode key
- 3-Power/Menu key
- 4-Sensitivity key
- 5-Down arrow key
- 6-light Key

-5-

When the FF918CS-T powers on, the **LUCKY** logo will temporarily display on screen last for 5seconds. Then will show **STARTUP**.

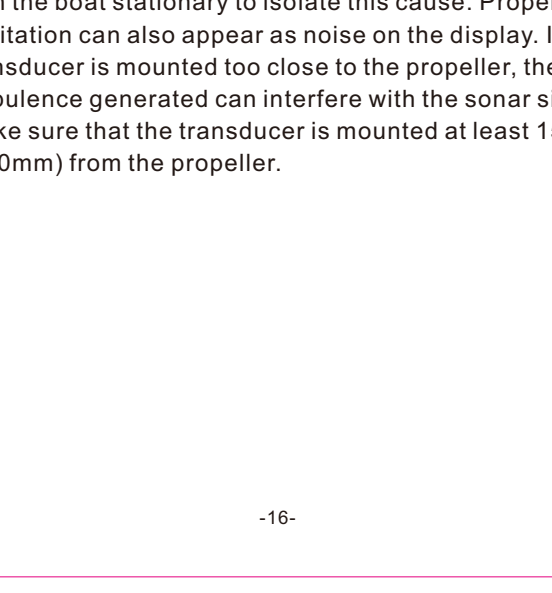

From this menu, use the arrow keys to select either Start-Up, Simulation.  
If you do nothing, the unit will default to normal on the water use.

**-Use Start-Up for on the water use.**

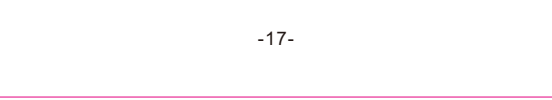

## 6. The Menu System

A simple menu system allows you to access your FF918CS-T adjustable settings. To activate the menu system, press the POWER-MENU key. Press the POWER-MENU key repeatedly to display the FF918CS-T menu settings, one at a time. When a menu setting is on the display, use the UP and DOWN Arrow keys to adjust the menu setting. Menus setting are removed from the screen automatically after several seconds. In Normal operating mode, most

-6-

menu settings saved to memory will not return to their default values when the unit is turned off. See individual menu choices for more information.

**NOTE:** Each time the POWER-MENU key is pressed, the backlight momentarily illuminates for easy viewing at night. Adjust the Brightness menu setting to keep the backlight on.

### 6.1 User mode---



Use the User Mode menu choice to change between these three user modes.

- 200KHz:** This user mode allows you to operate the FF918CS-T in 200KHz frequency. When you use 200KHz mode, the FF918CS-T can indicate fish found in the wide (20°) beam when the fish icon mode is turned on.
- 83KHz:** This user mode allows you to operate the FF918CS-T in 83KHz frequency. When use 83KHz mode, the FF918CS-T can indicate fish found in the wide (60°) beam when the fish icon mode is turned on.
- 200KHz/83KHz:** This user mode allows you to operate the FF918CS-T in 83KHz/200KHz frequency. When you use 200/83KHz mode, the FF918CS-T can be optimized to show the greatest bottom definition using a

-7-

narrow(20°)beam yet can still indicate fish found in the wide(60°) beam area when the fish icon mode is turned on.



### 6.2 Sensitivity---



Press the POWER-MENU key until SENSITIVITY appears. Sensitivity controls how much detail is shown on the display. Increasing the sensitivity shows more sonar returns from small baitfish and suspended debris in the water; however, the display may become too cluttered. When operating in very clear water or greater depths, increased sensitivity shows weaker returns that may be of interest. Decreasing the sensitivity eliminates the clutter from the display that is sometimes present in murky or muddy water. If Sensitivity is adjusted too low,

-8-

the display may not show many sonar returns that could be fish. (1 – 9).

### 6.3 Depth Range---



Press the POWER - MENU key until DEPTH RANGE appears. Automatic is the default setting. When in automatic, the lower range will be adjusted by the unit to follow the bottom. (Auto, 5-180)

**NOTE:** In manual operation, if the depth is greater than the depth range setting, the bottom will not be visible on the display. Select AUTO to return to automatic operation.

### 6.4 Zoom---



Press the POWER - MENU key until ZOOM appears. Select Auto to magnify the area around the bottom in order to reveal fish and structure close to the bottom that may not be visible during normal operation. When ZOOM is set to Auto, the upper and lower Depth Ranges are automatically adjusted to keep the area above and below the bottom on the display. Select Off to return to normal operation. (Off, Auto, 5-180).

-9-



There is also a series of manual ranges which can be selected. The manual depth ranges are determined by the present depth conditions.

### 6.5 Shallow Alarm ---

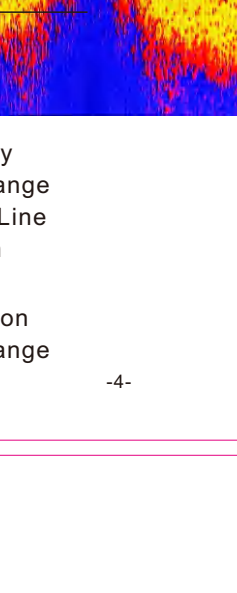

Press the POWER-MENU key until Shallow Alarm appears. Select OFF for no Depth Alarm, or select 5 to 180 meters to set the alarm depth. An audible alarm sounds when the depth is equal to or less than the setting. (Off, 5-180)

### 6.6 Fish Icon ---

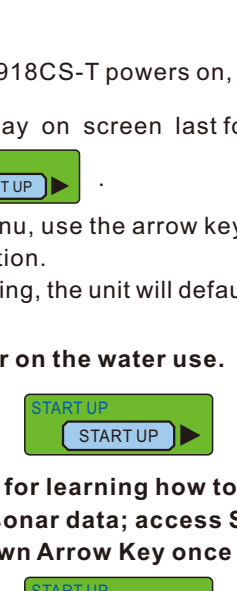

-10-

Make sure press the POWER-MENU key until Fish Icon appears. Select either Off to view "raw" sonar returns, or On to view Fish symbols. Fish icon uses advanced signal processing to interpret sonar returns, and will display a Fish Symbol when very selective requirements are met. A select number of possible fish returns will be displayed with their associated depth. (On, Off).

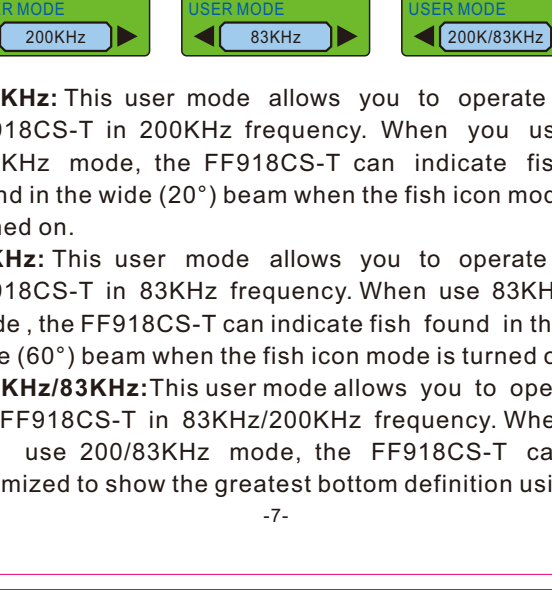

### 6.7 Fish Alarm---

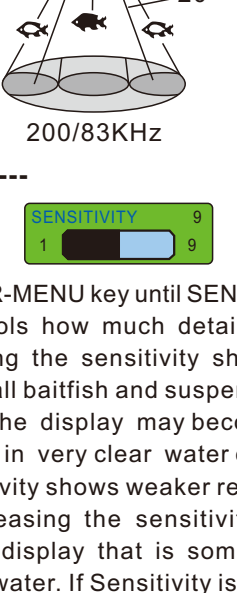

Press the POWER-MENU key until FISH ALARM appears. Select Off for no fish alarm, or one of the following symbols to set the alarm. An alarm will sound when the FF918 detects fish that correspond to the alarm setting. Fish Alarm will only sound if Fish ID+ is also set to On. (Off, Large, Large/Medium, All).

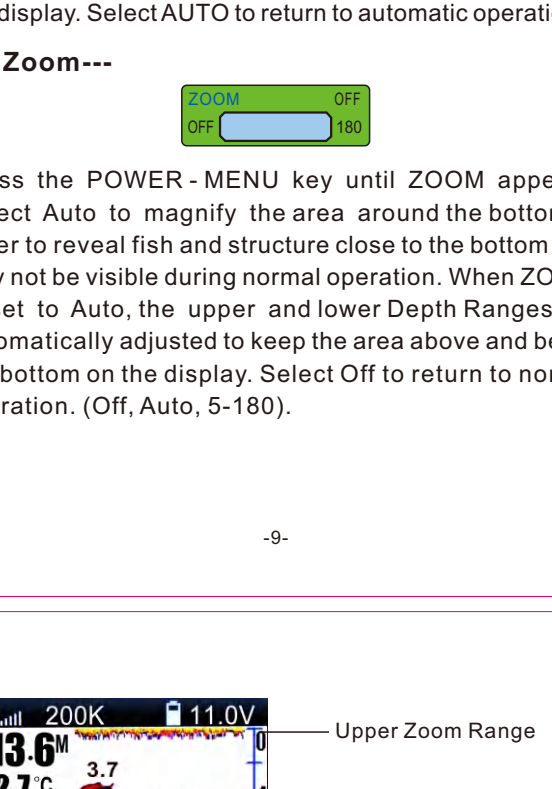

-11-

### 6.8 Units---

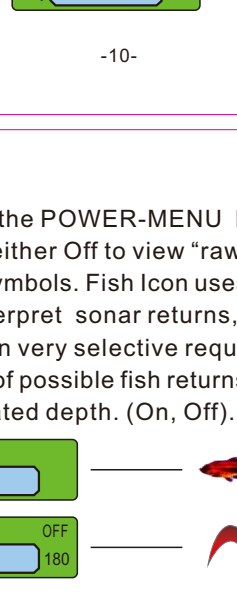

Make sure press the POWER-MENU key until UNITS appears. UNITS selects the units of measure. ( Feet/F, Meters/C, Feet/C, Meet/F ,where F stands for Fahrenheit and C stands for Celsius )

### 6.9 Color Tone---

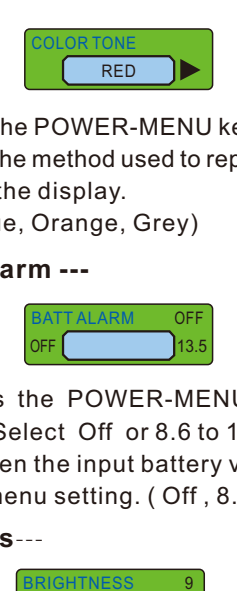

Make sure press the POWER-MENU key until Color Tone appears. Selects the method used to represent the bottom and structure on the display. (Red, Green, Blue, Orange, Grey)

### 6.10 Battery Alarm ---

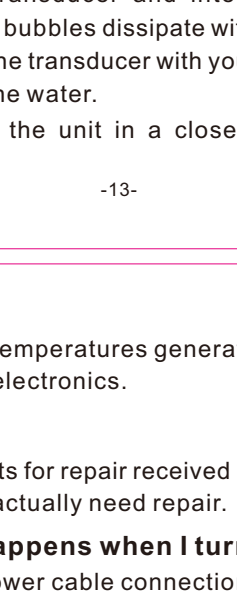

Make sure press the POWER-MENU key until Battery Alarm appears. Select Off or 8.6 to 13.5 Volts. Battery Alarm sounds when the input battery voltage is equal to or less than the menu setting. ( Off , 8.6 to 13.5 Volts )

### 6.11 Brightness ---

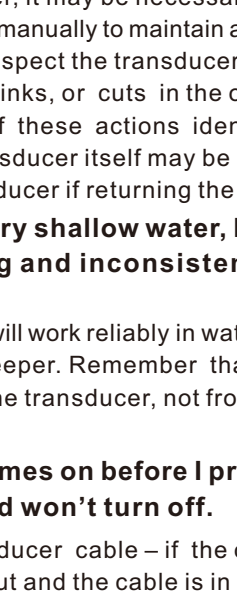

-12-

Press the POWER-MENU key until Brightness appears. Use the backlight for night fishing. Select 1-9 to activate the backlight at the desired level.

## 7. Maintenance

Follow these simple procedures to ensure your FF918-C180D continues to deliver top performance.

**7.1.** If the unit comes into contact with salt spray, wipe the affected surfaces with a cloth cleaned in fresh water.

**7.2.** Do not use a chemical glass cleaner on the lens - this may cause cracking in the lens.

**7.3.** When cleaning the LCD protective lens, use a chamois and non-abrasive, mild cleaner. Do not wipe while dirt or grease is on the lens. Be careful to avoid scratching the lens.

**7.4.** If your boat remains in the water for long period of time, marine growth can reduce the effectiveness of the transducer. Periodically clean the face of the transducer with liquid detergent.

**7.5.** If your boat remains out of the water for a long period of time, it may take some time to wet the transducer when returned to the water. Small air bubbles can cling to the surface of the transducer and interfere with proper operation. These bubbles dissipate with time, or you can wipe the face of the transducer with your fingers after the transducer is in the water.

**7.6.** Never leave the unit in a closed car or trunk - the

-13-

extremely high temperatures generated in hot weather can damage the electronics.

## 8. Trouble

Many requests for repair received by LUCKY involve units that do not actually need repair.

### 8.1. Nothing happens when I turn the unit on.

**1.)** Check the power cable connection at both ends. Be sure the cable is connected correctly to a reliable power source – red lead to positive, black lead to negative or ground. Ensure the power available is between 10 and 20 V DC.

**2.)** Check the power connection to the FF918CS-T. It is possible to force the power cable connector into the cable holder incorrectly. If the connector is reversed, the unit will not work. Examine the contacts on the back of the unit to ensure there is no corrosion.

### 8.2. There is no transducer detected.

The FF918CS-T has the ability to detect and identify that a transducer is connected. When powering on, make sure that an appropriate transducer connector is plugged into the unit. In addition, inspect the transducer cable from end to end for breaks, kinks, or cuts in the outer casing of the cable. Also make sure that the transducer is fully submerged in water. If the transducer is connected to the unit through a switch, temporarily connect it directly to the unit and try again. If none of these action identifies an obvious problem, the transducer

-14-

itself is probably at fault. Be sure to include the transducer if returning the unit for repair.

### 8.3. There is no bottom reading visible on the display.

In very deep water, it may be necessary to increase the sensitivity setting manually to maintain a graphic depiction of the bottom. Inspect the transducer cable from end to end for breaks, kinks, or cuts in the outer casing of the cable. If none of these actions identifies an obvious problem, the transducer itself may be at fault. Be sure to include the transducer if returning the unit for repair.

### 8.4. When in very shallow water, I get gaps in the bottom reading and inconsistent digital depth indication.

The FF918CS-T will work reliably in water 3 feet (0.9 meters) or deeper. Remember that the depth is measured from the transducer, not from the surface of the water.

### 8.5. The unit comes on before I press the POWER -MENU key, and won't turn off.

Check the transducer cable – if the outer jacket of the cable has been cut and the cable is in contact with bare metal, you will need to repair the cut with electrical tape. If there is no problem with the cable, disconnect the transducer from the unit and see if the problem is corrected.

-15-

### 8.6. The display begins to fade out. Images are not as sharp as normal.

Check the input voltage. The FF918CS-T will not operate on input voltages below 10 V DC.

### 8.7. The display shows many black dots at high speeds and high sensitivity settings.

You are seeing noise or interference caused by one of several sources. Noise can be caused by electronic devices. Turn off any nearby electronics and see if the problem goes away. Noise can be caused by the engine. If engine noise is causing the interference, the problem will intensify at higher RPMs. Increase the engine speed with the boat stationary to isolate this cause. Propeller cavitation can also appear as noise on the display. If the transducer is mounted too close to the propeller, the turbulence generated can interfere with the sonar signal. Make sure that the transducer is mounted at least 15" (380mm) from the propeller.

-16-

## 9. Specifications

Depth Capability:-----590 feet (180m)  
Power Output:-----100 Watts  
Sonar Operating Frequency:-----200 KHz/83KHz,  
Dual Beams

Sonar Coverage:----- 60° @-10 db in 83KHz;  
20° @-10 db in 200KHz

LCD Matrix: -----MVA-TFT-LCD,65536  
Colors,320V x 480H

Transducer Cable Length: -----20 ft (6m)  
Control Head Power Requirement:-----8X AA 1.5 Volt  
Alkaline batteries (not included)



MANUFACTURER: JINHUALUCKY ET MANUFACTURER CO.,LTD.

-17-